



Operating manual
data logger THI · THIP · TCO

BA-THI-THIP-TCO-05-EN

Table of contents

Content	Page
1. Safety	2
2. Intended use	2
3. Equipment	3
4. Scope of supply	3
5. Preparation before starting	4
5.1. Software	4
5.1.1. Installation conditions	4
5.1.2. Installation of the SmartGraph software	4
5.1.3. Preparing data logger configuration	4
5.2. Note at initial startup	4
6. Operation	4
6.1. Switching on and off	4
6.2. Basic settings and operating modes	4
6.2.1. The four operating modes	4
6.2.2. Network function (M51)	5
6.2.3. Factory settings (M52)	6
6.2.4. Acoustic function (M53)	6
7. Measured values display and data recording	6
7.1. Sensors, channel groups and measuring channels	6
7.2. Displaying measured values	7
7.3. Data recording	7
8. Alarm function	7
8.1. Alarm configuration	7
8.2. Alarm display	7
8.3. Acoustic alarm	7
8.4. Using the alarm hysteresis	8
9. Notes on maintenance and operation	8
9.1. Battery change	8
9.2. Deleting measured data	8
9.3. Positioning for mobile use	8
9.4. Mounting on a wall	8
9.5. Moving to another site	8
10. Technical data	9
11. Status codes	9

In order to use your data logger according to its intended use and utilise its complete range of functions, carefully read all documentation about this device.

This **operating manual** describes the functions of the hardware.

A separate manual – the **software manual** – describes how to use the software and configure the data logger with the software and can be opened after the software has been installed by using the help function in the software.

Your new data logger was built according to current state-of-the-art technology and fulfils valid European and national directives. This conformity has been tested and the corresponding declarations and documents are kept on file by the manufacturer.

To maintain this condition and ensure safe operation, as a user, you must observe the following safety instructions:

1. Safety

We accept no liability for damages caused by non-observance of this manual or unprofessional handling. Any warranty claims are voided in such cases!



Before starting the measuring device for the first time, read this manual from front to back!

For reasons of safety and conformity (CE), any unauthorised changes made to the device construction or components which are to be used with the measuring device are prohibited!

Before using the device, observe the following:

- *Never measure live parts.*
- *Observe the storage and operating conditions.*
- *The user is the only party who is responsible for determining measured results as valid, who can draw conclusions and take actions! The correctness of the results presented is excluded from any liability or guarantee. Liability for damages which have been caused by utilising the presented measured results is strictly excluded.*

2. Intended use

The data logger is designed to detect and record a range of measured values that can be detected by measuring device sensors described in the technical data. The measured data can be detected at variable selectable recording or request intervals, then saved and transmitted to a connected PC.

The measuring device may only be used for this intended use while complying with specified technical data.

Any other use is considered misuse and contrary to the intended use.



The product must not be disposed of with household waste. Dispose of this device in a manner compliant with the relevant legal requirements.

This release replaces all previous releases. No part of this publication may be reproduced without written permission. The same applies for electronically processing, duplicating or spreading the publication. Subject to technical changes. All rights reserved. Trademarks are used without guarantee that they may be used freely and primarily following the spelling of the manufacturer. The product names used are registered and should be treated appropriately. Changes to construction in the interests of constant improvements to the product, as well as changes to the shape and colour are reserved. The delivered product may vary from product images. This document was produced with all due care. We accept no liability whatsoever for mistakes or omissions.

3. Equipment

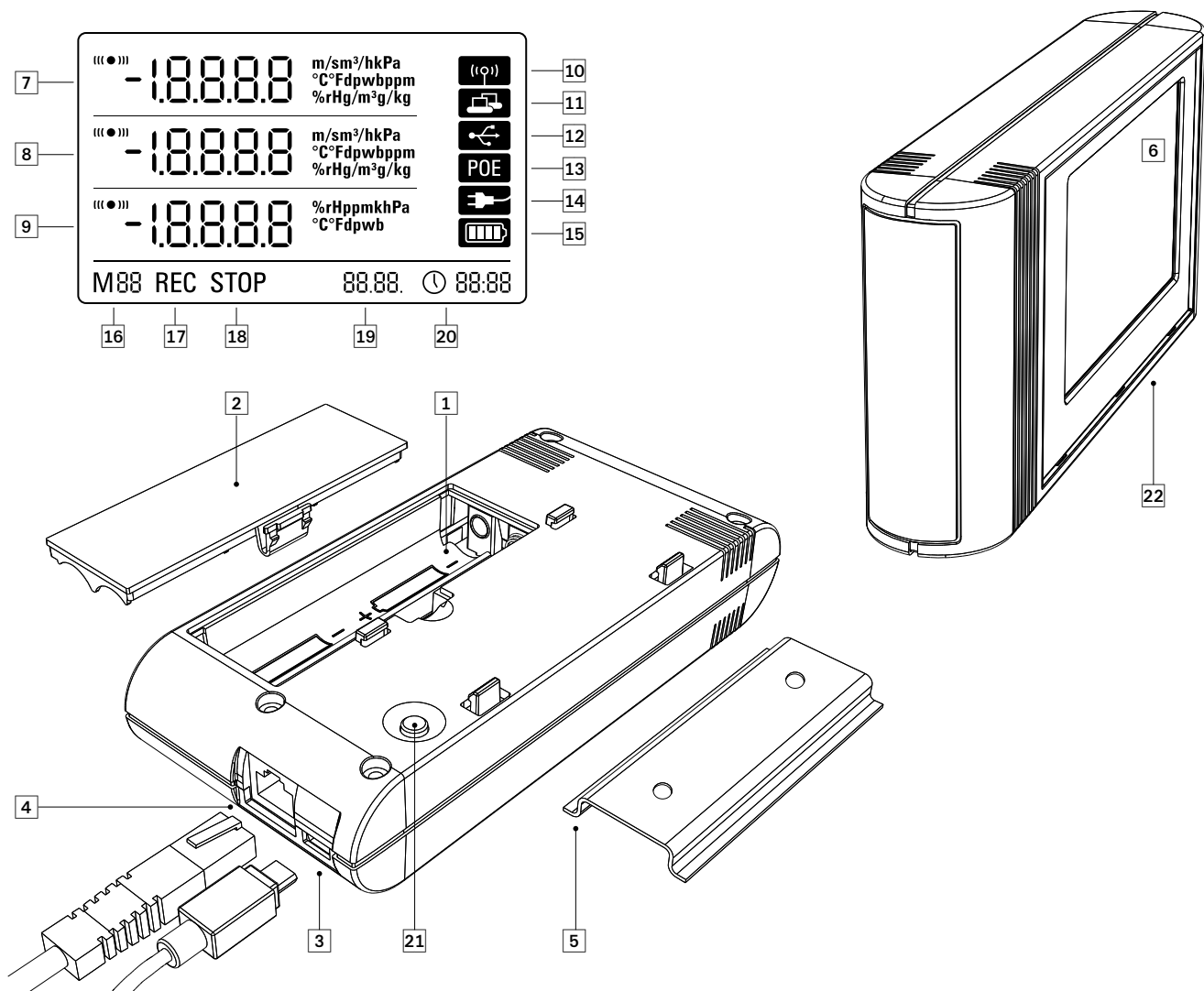

- ① Battery compartment
- ② Battery cover
- ③ PC connection USB type micro B
- ④ Network connection RJ45
- ⑤ Mount track for fastening
- ⑥ LCD display:
 - ⑦ Measured value row 1
 - ⑧ Measured value row 2
 - ⑨ Measured value row 3
 - ⑩ Display symbol for active acoustic signal
 - ⑪ Display symbol for active network connection
 - ⑫ Display symbol for active USB connection
 - ⑬ Display symbol for power supply over a network
 - ⑭ Display symbol for power supply over USB
 - ⑮ Display for battery level
 - ⑯ Display for mode marker
 - ⑰ Display for active measured value recording
 - ⑱ Display for inactive measured value recording
 - ⑲ Display for date
 - ⑳ Display for time
- ⑰ Mode selection button
- ⑱ Data logger with internal sensors (THI /THIP /TCO)

4. Scope of supply

The following components are included in the standard scope of supply:

- Data logger
- USB connection cable
- CD-ROM with operating manual, SmartGraph software and software manual
- Factory certificate

5. Preparation before starting

5.1. Software

5.1.1. Installation conditions

To configure your data logger and read the recorded measured values, the SmartGraph software must be installed on a PC with the following minimum requirements.

Supported operating systems:

- Windows XP from Service Pack 3 (32 bit or 64 bit version)
- Windows Vista (32 bit or 64 bit version)
- Windows 7 (32 bit or 64 bit version)

Hardware requirements:

- Processor speed: 1 GHz, minimum
- CD-ROM drive
- USB or network connection RJ45
- 512 MB RAM, minimum
- 4 GB of free hard disk space, minimum
- Adobe Acrobat Reader software

5.1.2. Installation of the SmartGraph software

Insert the CD-ROM into your PC drive and install the software by following the instructions in the installation wizard.

5.1.3. Preparing data logger configuration

Connect the data logger to your PC via the USB cable provided in the scope of supply. The measuring device is automatically detected by the operating system.

Alternatively, you can configure your data logger via a LAN connection over your local network if the network function is enabled. Further information about the network function is provided in chapter 6.2.2.

Start the SmartGraph software. The program automatically detects the connected data logger and adds it to the list of available data loggers. The data logger can now be configured via the software.

Further detailed information about using the software is provided in the software manual which you can open from the help function of the SmartGraph software.

Functions of the professional version

Information about upgrading your SmartGraph software to the professional version (improving the device license) is provided in the software manual.

5.2. Note at initial startup



After starting the device for the first time, the message "SET TIME" appears on the display. However, no settings need to be made directly on the device. The time synchronises itself with the PC time automatically when connected to the SmartGraph software for the first time.

6. Operation

The PC software SmartGraph is the central configuration interface for your data logger. All additional configuration and visualisation specifications can only be set by software.

Basic settings can be directly configured with one-button operation by using the mode selection button on your data logger.

You can restrict the one-button operation with the mode selection button from your software if necessary (key lock). It is not possible to operate your data logger with the mode selection button in this case.

6.1. Switching on and off

When current is being supplied, the data logger cannot completely switch off, but can only be set to an operating mode with minimal energy consumption (M1). In this mode, measured value detection, measured value display and data recording are inactive. An overview of the four various operating modes is provided in the next chapter.

6.2. Basic settings and operating modes

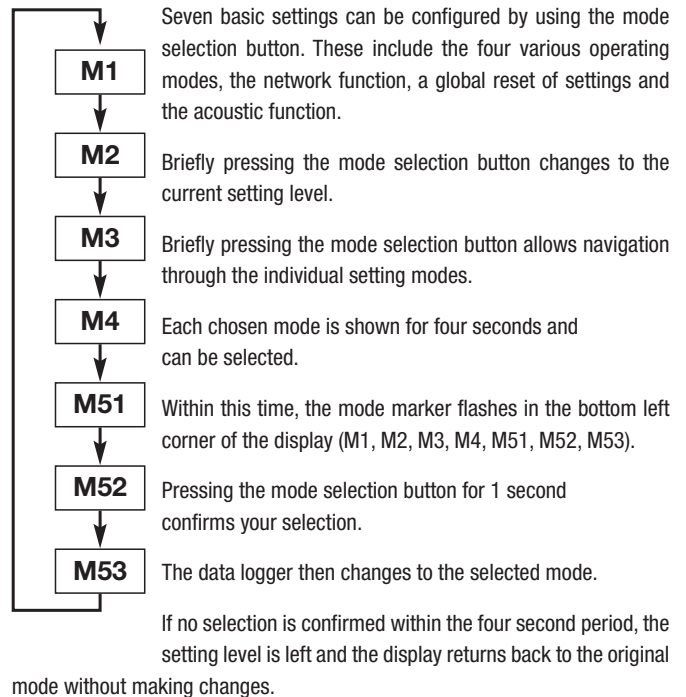

6.2.1. The four operating modes

Operating mode M1

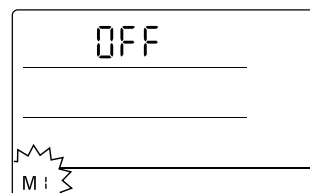

Selection of the operating mode M1

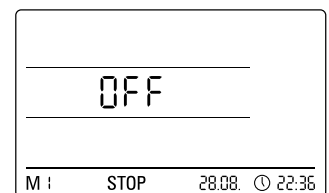

Display of the operating mode M1

Measured value recording is inactive. "OFF" is shown in the second measured value row. The STOP symbol is shown.

In this operating mode (data logger delivery state), the power consumption is minimal because measured values cannot be requested or shown.

Operating mode M2

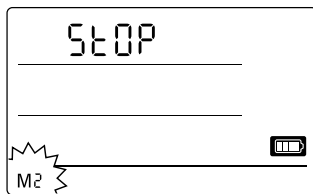

Selection of the operating mode M2

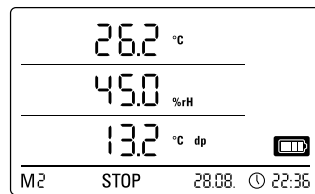

Example display of the operating mode M2

Measured value detection is active. The measured values which have been configured in the SmartGraph software are shown in all three measured value rows at the selected sensing rate.

In this operating mode, data recording is inactive; the displayed measured values are not saved in the memory. The display for measured value recording thus shows STOP (no data recording).

Operating mode M3

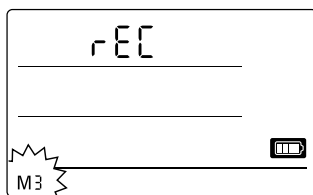

Selection of the operating mode M3

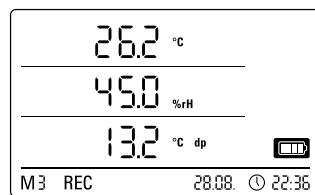

Example display of the operating mode M3

Measured value detection and data recording are active. The measured values which have been configured in the SmartGraph software are shown in all three measured value rows at the selected sensing rate.

Additionally, in this operating mode, up to twenty measuring channels, which can be selected in the SmartGraph software, are stored in the measured value memory. The display for measured value recording thus shows REC (data recording).

Operating mode M4

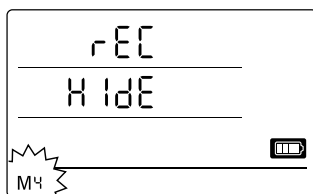

Selection of the operating mode M4

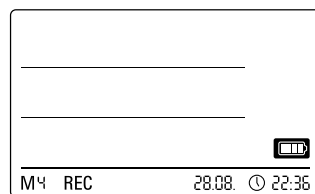

Display of the operating mode M4

Measured value detection and data recording are active; but measured value display is inactive.

Measured values are not shown in any of the three measured value rows. Still, in this operating mode, up to twenty measuring channels, which can be selected in the SmartGraph software, are stored in the measured value memory. The display for measured value recording thus shows REC (data recording).

6.2.2. Network function (M51)

Requirements for connecting over a IPv4 network.

To automatically identify the IP configuration of a data logger (which has received an IP address in the IP network via DHCP for example), it is necessary that UDP broadcasts are allowed through the network.



Note: Based on their concept, UDP broadcasts do not operate through a router (NAT), but instead only within its own network.

If the data logger is outside of the network, using fixed IP addresses through a system administrator is highly recommended.

Connect to the network

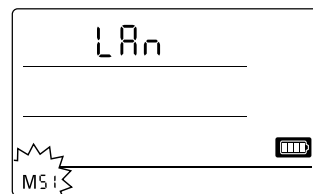

Selection of the network function M51

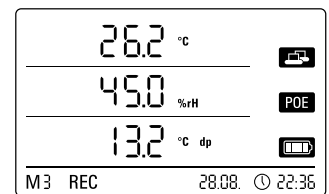

Example display of the network function M51

If the data logger is connected to a local network and the network function is activated, then software configuration and data reading from the data logger can be carried out over the network.

A signal which is broadcast from the data logger over UDP allows the SmartGraph software to automatically find the measuring device in the local network.

The first time that the data logger is connected to the network (add network device), it may be necessary to adjust the data logger's network settings to the configuration of the available network in the SmartGraph software. The factory preset is DHCP.

Further information about the network function is provided in the software manual which you can open from the help function of the SmartGraph software.

With the professional version of the SmartGraph software, it is also possible to retrieve and log current and saved measured values of the data logger in adjustable request intervals over the network.

Use in network mode

For continuous use of the network card, the data logger must be mounted on a wall. There must be free air convection within a gap of a half metre and the zone must not be interrupted by external sources of convection (fans, lighting etc.).

Power supply in network mode

Using the network card, which is built into the data logger, raises the power consumption of the measuring device.

When the device is running on batteries alone and not connected to an external power supply, it automatically deactivates the network function after 12 minutes without communicating with the network. In this case, the network function must be restarted by an external power supply either manually or automatically.



When using the data logger in LAN mode, the power should thus be supplied by a USB power supply.

In the optionally available PoE design, the data logger can have its power supplied directly over the network connection.

Information for system administrators

Broadcast over UDP:

PC sends toUDP:255.255.255.255:52010
(data logger receives at UDP port 52010*)

data logger replies toUDP:255.255.255.255:52005
(PC receives at UDP port 52005*)

Data transmission over TCP:

data logger receives at TCP port 52015*

* The ports can be reconfigured, but this is not recommended.

Open or lost TCP connections are closed by the data logger after a TCP timeout of 120 seconds.

6.2.3. Factory settings (M52)

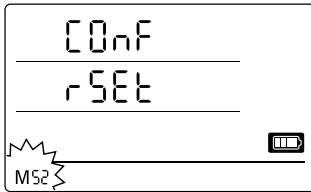

Selection of the reset function M52

This function resets the device settings to factory settings.

Even when resetting the device to factory settings or when there are no batteries in the device, the measurement data remains in the memory and is not deleted.

Information about deleting the measured data is provided in chapter 9.2.

6.2.4. Acoustic function (M53)

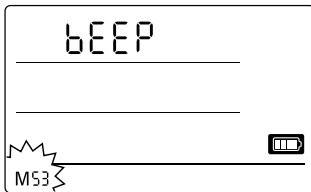

Selection of the acoustic function M53

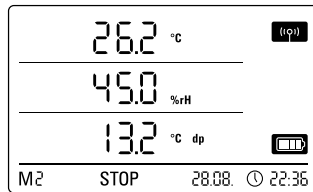

Example display of the acoustic function M53

Activating or deactivating the acoustic function switches the data logger's acoustic signal either on or off. If the acoustic function is active, the function's display symbol is shown on the display.

When the acoustic function is active, alarm results are indicated as a tone, provided an active alarm has been preset for one or more of the three display measured values in the SmartGraph software.

If the acoustic function is not active, then none of the navigation steps which require the mode selection button on the data logger to be pressed are acknowledged by a tone. The same applies for selecting a mode. If no selection is made, and thus the setting level is exited, then a tone is also emitted.

7. Measured values display and data recording

7.1. Sensors, channel groups and measuring channels

Model THI

The THI data logger has two internal sensors to detect measured values from a total of six channel groups. These channel groups (measured values) are: Air temperature in °C, air temperature in °F, dew point in °C, dew point in °F, relative humidity in % and absolute humidity in g/m³.

For each channel group, there are four measuring channels for recording: Current measured value (cur), minimum measured value (min), maximum measured value (max) and average measured value (mid). In total, there are 24 measuring channels available for your THI data logger, as shown in table 1.

Model THIP

The THIP data logger has three internal sensors to detect measured values from a total of eight channel groups. These channel groups (measured values) are: Air temperature in °C, air temperature in °F, dew point in °C, dew point in °F, relative humidity in %, absolute humidity in g/m³, relative air pressure in hPa and absolute air pressure in hPa.

For each channel group, there are four measuring channels for recording: Current measured value (cur), minimum measured value (min), maximum measured value (max) and average measured value (mid). In total, there are 32 measuring channels available for your THIP data logger, as shown in table 1.

Table 1: Overview of sensors, channel groups (measured values) and measuring channels of the data logger

Sensor / measured value sensor		Channel group (measured value)	Unit	Available measuring channels for data recording (max. 20 channels available for saving) and for displaying* (max. 3 channels for display)				Displayable in the display-measured value row
all models	internal temperature sensor	Temperature	[°C]	cur	min	max	mid	1, 2, 3
		Temperature	[°F]	cur	min	max	mid	1, 2, 3
		Dew point	[°C]	cur	min	max	mid	1, 2, 3
		Dew point	[°F]	cur	min	max	mid	1, 2, 3
	internal humidity sensor	Relative humidity	[%]	cur	min	max	mid	1, 2, 3
		Absolute humidity	[g/m ³]	cur	min	max	mid	1, 2
only THIP	internal air pressure sensor	Relative air pressure**	[hPa]	cur	min	max	mid	1, 2, 3
		Absolute air pressure	[hPa]	cur	min	max	mid	1, 2, 3
only TCO	internal carbon dioxide sensor	CO ₂ concentration**	[ppm]	cur	min	max	mid	1, 2, 3

* When selecting a channel for display, the current measured value (cur) is always automatically shown.

** For more specific determination of measured values, entering the site height via the SmartGraph software is necessary.

Model TCO

The TCO data logger has three internal sensors to detect measured values from a total of seven channel groups. These channel groups (measured values) are: Air temperature in °C, air temperature in °F, dew point in °C, dew point in °F, relative humidity in %, absolute humidity in g/m³ and CO₂ concentration in ppm.

For each channel group, there are four measuring channels for recording: Current measured value (cur), minimum measured value (min), maximum measured value (max) and average measured value (mid). In total, there are 28 measuring channels available for your TCO data logger, as shown in table 1.

7.2. Displaying measured values

One of the channel groups specified in table 1 for displaying measured values can be configured to be displayed on each of the three measured value rows. Here, the current measured value is always shown on the display.

7.3. Data recording

If either of the operating modes M3 or M4 are selected, then the data logger is in logging mode (REC) and the measured values of the measuring channels selected for recording are saved in the device.

Up to 20 of the measuring channels specified in table 1 can be simultaneously recorded in the data memory of the measuring device.

Recording begins immediately from the moment that the operating mode M3 or M4 is selected and is carried out in ring mode. This means that when the memory limits are reached, the recording does not stop but continues to record. The older values are simply overwritten by the newest measured values.



Tip: Current, minimum, maximum and average measured values for a channel group each represent one measuring channel. If these values should be available for later documentation and evaluation, each of the measuring channels must already be selected during memory organization for recording, because it is not possible to calculate these values in the software.

The specifications for type, duration and scope of data recording in the logging mode can be individually set in the software. Detailed information is provided in the software manual.

8. Alarm function

8.1. Alarm configuration

An alarm function can be configured in the measuring device administration for each of the measuring channels selected for display or recording.

By defining an upper and lower alarm limit value, a value corridor is specified. This is the so-called good range and when the range is exited, an alarm sounds.

Note: The alarm function can only be represented on the display for the channel groups of the three measuring channels selected for measured value display, and only in the operating modes M2 and M3!

However, saving alarm results of other selected measuring channels in logging mode is independent of the selected display of the measured values. That means that the alarm results of the measuring channels which are not for display but for data recording are also recorded.

Even in the operating mode M4 when displaying measured values is deactivated, all preselected alarm results are recorded!

8.2. Alarm display

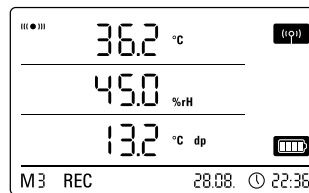

Example display for an alarm result of the measuring channel shown in the first measured value row.

The alarm display is only possible for measured values which are preselected for displaying and which have been configured with an active alarm function.

If an alarm occurs at one of these measuring channels, the alarm symbol flashes beside the measured value display for this channel while the good range is exited.

If the measured value then reaches the defined value corridor, that is, the good range, then the alarm symbol stops flashing and is shown continually.

This indicates that an alarm result has occurred. If the good range is exited during the course of a measurement, the alarm symbol flashes again.

Reading the measured value memory deletes the alarm display.

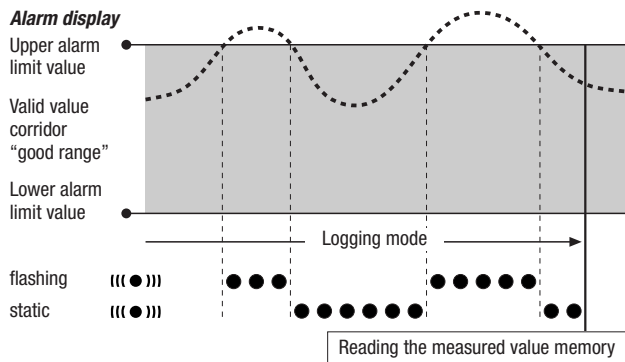

Additionally, a hysteresis can be set by which the measured value must return to the valid range to switch off the alarm.

8.3. Acoustic alarm

If an alarm goes off while the acoustic function is activated (see chapter 6.2.4. Acoustic function), then an alarm tone sounds and only stops when the measured value returns to the good range.

8.4. Using the alarm hysteresis

If you use the alarm function without alarm hysteresis, then an alarm sounds and is recorded each time the preset limit values are exceeded.

If your limit values have been selected very close to each other, then this means that an alarm situation occurs very often.

For example, if you set a room temperature of 24 °C as the upper alarm limit and a room temperature of 10 °C as the lower alarm limit and the room temperature continually deviates between 23.5 and 25 °C during the measuring period, then there will be many individual alarm signals created and recorded.

To prevent this, you can define an alarm hysteresis. With this setting, you define a value by which the measured value must have returned to the valid value corridor, the good range, to switch off the alarm.

If an alarm hysteresis of 1 °C was set, the alarm in the previous example would go off once as 24 °C was exceeded and then only stop as the temperature drops below 23 °C again.

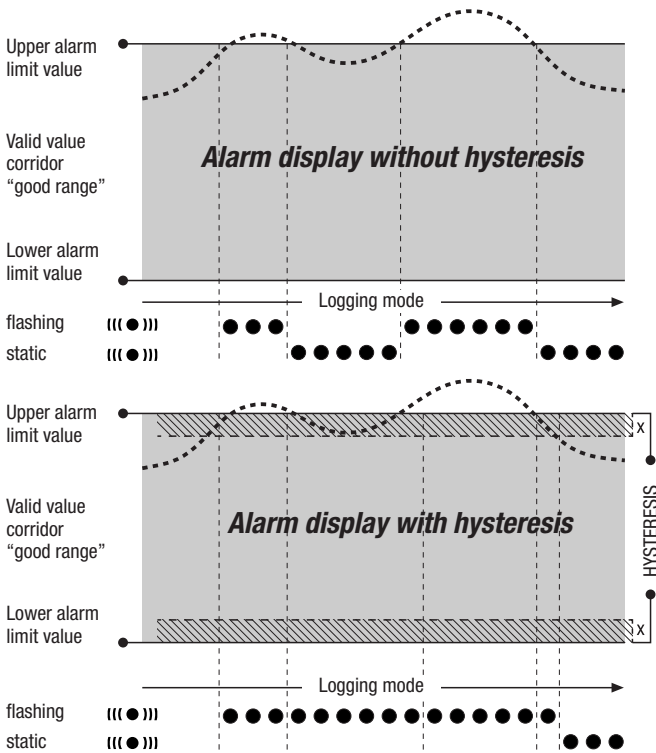

9. Notes on maintenance and operation

9.1. Battery change

If “LO bAtt” appears in the upper row of the display, then the batteries need to be changed.



Data cannot be recorded while batteries are being changed. If data recording is running, pause it and ensure that the data logger is in operating mode M1 or M2 before changing the batteries.

To replace the batteries, open the battery compartment, remove the used batteries and then insert new batteries, while observing the correct poles.

Time is maintained for at least a minute during battery change, even when batteries are not inserted.

Only use appropriate batteries which comply with the technical data. Other types of batteries can cause operating errors. Do not use rechargeable batteries!

Do not dispose of used batteries in the household rubbish or throw them in the fire; instead, dispose of them according to the relevant legal requirements.

9.2. Deleting measured data

The detected measured data are permanently saved in the internal Flash memory. Even when resetting the device to factory settings or when there are no batteries in the device, the measurement data remains in the memory and is not deleted.

Saved data can only be deleted via the SmartGraph3 software as a whole and not individually.

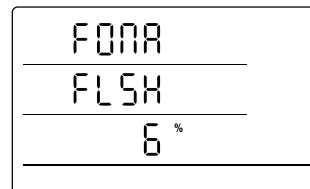

Display for deleting measured data. In the display, 6 % of the data have been deleted so far.

The deletion process takes approx. 2 minutes. During this time, the following messages appears on the display: “FOMA FLSH xxx %”.

During the entire deletion period, access to the device is not possible and it does not respond to requests from the SmartGraph3 software.

After memory has been completely deleted, “FOMA FLSH 100 %” is shown on the display. Afterwards, the display returns to normal operation.

Further detailed information about using the software is provided in the software manual which you can open from the help function of the SmartGraph software.

9.3. Positioning for mobile use

For mobile measured value recording, the data logger can be positioned at any site. Observe the permissible ambient conditions for operation (see technical data). Due to its compact dimensions, the data logger can be hidden for non-intrusive applications.

9.4. Mounting on a wall

For stationary data detection, the data logger can also be mounted on a wall or a similar holding device. A mount track is included in the scope of supply for fastening.



For network operation, wall mounting is absolutely necessary. Additional information about network operation is provided in chapter 6.2.2.

9.5. Moving to another site

Especially when moving from cold to warm ambient conditions, e.g. when moving into a heated room after storage in a car over night, depending on humidity in the room, condensation may form on the printed circuit board.

This physical trait can lead to false measured values. Unfortunately, it is necessary for the construction and cannot be prevented in any measuring devices. In these cases, please wait approx. 5 minutes until the measuring device has “acclimatised” before starting to measure.

10. Technical data

Technical data of the data loggers		THI	THIP	TCO
Air temperature	Operating principle	NTC		
	Measuring range	-20 °C to + 50 °C		
	Accuracy	± 0.3 °C (0...40 °C), otherwise 0.5 °C		
	Screen resolution	0.1 °C		
Relative humidity	Operating principle	capacitive		
	Measuring range	0 to 100 % RH		
	Accuracy	±2 % RH		
	Screen resolution	0.1 % RH		
Air pressure	Measuring range	–	300 ... 1,300 hPa abs.	–
	Accuracy	–	700 ... 1,100 mbar at 25 °C ±0.5 hPa	–
	Screen resolution	–	0.1 hPa	–
CO ₂ concentration	Operating principle	–	–	NDIR
	Measuring range	–	–	0 ... 5,000 ppm
	Accuracy	–	–	±50 ppm +3 measured value at 20 °C and 1,013 mbar
	Screen resolution	–	–	1 ppm
	Long term stability	–	–	20 ppm/a
Memory organisation	Sensing interval	10/30 s, 1/10/12/15/30 min, 1/3/6/12/24 h		
	Saving interval	1/10/12/15/30 min, 1/3/6/12/24 h		
	Data storage	16 MB, 3,200,000 measured values		
	Data recording	up to 20 simultaneous measuring channels		
Configuration and dimensions	LCD display	W 90 x H 64 mm		
	Housing	Plastic		
	Dimensions	L 166 x W 32 x H 78 mm		
	Weight	approx. 250 g		
	Interfaces	USB, LAN		
Power supply	internal	4 x LR6 AA batteries, battery life > 1 year	4 x LR6 AA batteries, battery life > 1 year	4 x LR6 AA batteries, battery life 2 to 6 months (depending on the sensing rate)
	external	USB, LAN (PoE configuration)		
Permissible operating ambient conditions	Air temperature	-20 °C to +50 °C		
	Relative humidity	0 to 95 % RH, < 20 g/m ³ (non-condensing)		
	Height	10,000 m above sea level		
Scope of supply	Standard	Measuring device, CD-ROM with SmartGraph 3 PC software for representing the evaluation of measured values graphically and numerically and operating manual, USB connection cable, batteries		
	Optional	Measuring device in PoE configuration		

11. Status codes

In the event of a sensor error, the following codes may appear on one of the three LCD rows instead of the measured value

E 2CInitialisation error at the sensor

E 27Faulty calibration data

E 36Channel disabled (e.g. channel configured in the LCD, but sensor logged off or removed)

E 50Value to be displayed too large to fit on display

E 51Value to be displayed too small to fit on display

E 52Channel value in the saturation (upper limit)

E 53Channel value in the saturation (lower limit)

E 54Data error. Received data are not plausible

E 55Measurement not possible of sensor not reachable